

LOADING CONSIDERED:
 DEAD LOADS: SELF-WEIGHT.
 LIVE LOADS: AS PER IBC 2006 / ASCE 7-05 CODE REQUIREMENTS-
 200 psf UNIFORM / 490 #/ft ACROSS BARS IN BAR GRATING.
 WIND LOADS: AS PER IBC 2006 / ASCE 7-05 / TIA-222-G STANDARD CODE REQUIREMENTS-
 40 psf (FROM 120 Mph PER IBC 2006 / ASCE 7-05 METHOD).
 (4) MAX. EXPOSED CABINETS WITH DIMENSIONS OF UP TO 60" WIDE X 80" TALL.
 SNOW LOAD: 90 psf UNIFORM
 GUARD RAILS: 50 plf/200 lbs ANY DIRECTION

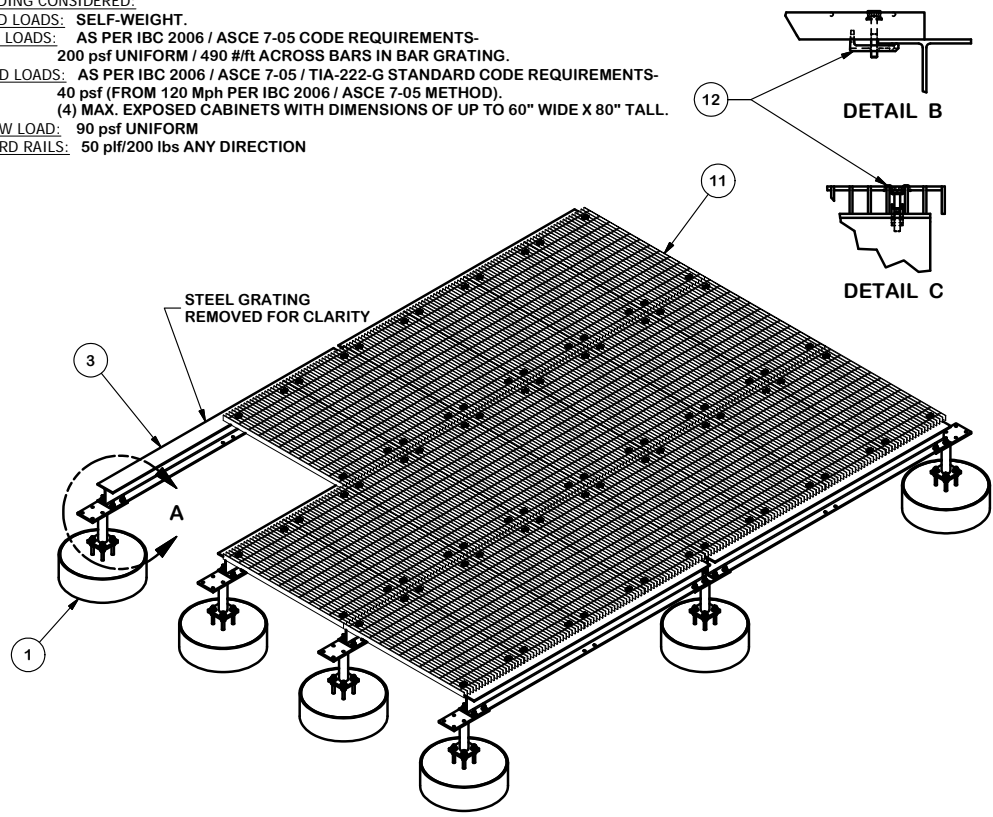

PARTS LIST						
ITEM	QTY	PART NO.	PART DESCRIPTION	LENGTH	UNIT WT.	NET WT.
1	12	PAD-C	CONCRETE PAD FOR PLATFORM		327.78	3933.36
2	12	X-151785	FOUNDATION CONNECTION ASSEMBLY FOR EQUIPMENT PLATFORM		35.97	431.69
3	8	X-151588	W6 X 15# WIDE FLANGE (Fy=35 Ksi Min)		123.90	991.20
4	96	G58FW	5/8" HDG USS FLATWASHER		0.07	6.76
5	44	G58LW	5/8" HDG LOCKWASHER		0.03	1.15
6	96	G58NUT	5/8" HDG HEAVY 2H HEX NUT		0.13	12.45
7	64	G12212	1/2" x 2-1/2" HDG HEX BOLT GR5	2 1/2 in	0.20	13.03
8	128	G12FW	1/2" HDG USS FLATWASHER		0.03	4.36
9	64	G12LW	1/2" HDG LOCKWASHER		0.01	0.89
11	24	X-151787	STEEL GRATING - 24"W X 48"L - BEARING BAR 1 3/4" X 3/16"		97.27	2334.37
12	96	X-151174	GRATING CONNECTION CLAMP		0.36	34.09
10	64	G12NUT	1/2" HDG HEAVY 2H HEX NUT		0.07	4.58
					TOTAL WT. #	7767.95

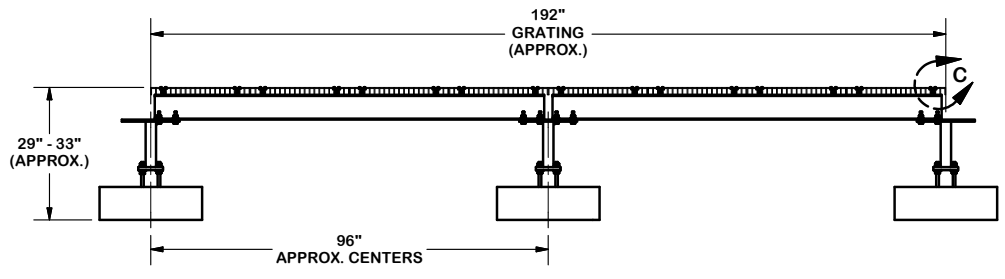
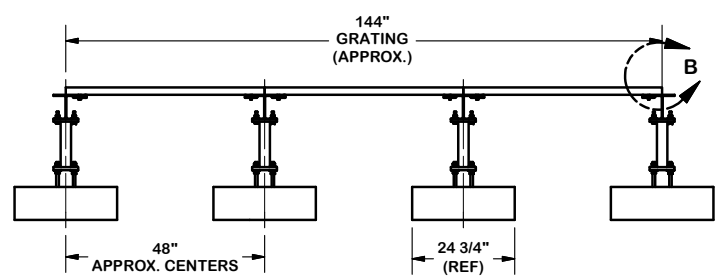
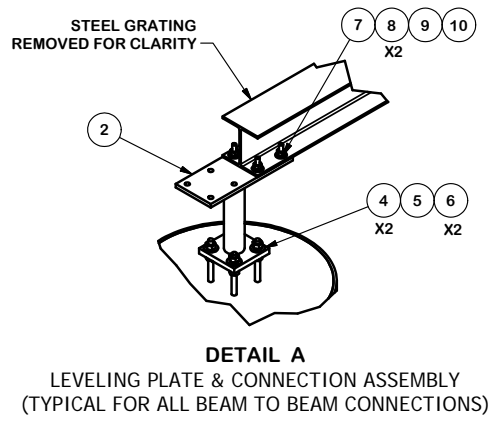

TOLERANCE NOTES
 TOLERANCES ON DIMENSIONS, UNLESS OTHERWISE NOTED ARE:
 SAWED, SHEARED AND GAS CUT EDGES ($\pm 0.030"$)
 DRILLED AND GAS CUT HOLES ($\pm 0.030"$) - NO CONING OF HOLES
 LASER CUT EDGES AND HOLES ($\pm 0.010"$) - NO CONING OF HOLES
 BENDS ARE $\pm 1/2$ DEGREE
 ALL OTHER MACHINING ($\pm 0.030"$)
 ALL OTHER ASSEMBLY ($\pm 0.060"$)

PROPRIETARY NOTE:
 THE DATA AND TECHNIQUES CONTAINED IN THIS DRAWING ARE PROPRIETARY INFORMATION OF VALMONT INDUSTRIES AND CONSIDERED A TRADE SECRET. ANY USE OR DISCLOSURE WITHOUT THE CONSENT OF VALMONT INDUSTRIES IS STRICTLY PROHIBITED.

DESCRIPTION		EQUIPMENT PLATFORM BASE UNIT ASSEMBLY 12' X 16'	
CPD NO.	DRAWN BY	ENG. APPROVAL	
	KC8 9/25/2012		
CLASS	DRAWING USAGE	CHECKED BY	
81	CUSTOMER	CEK 2/18/2013	

 A valmont COMPANY	Locations: New York, NY Atlanta, GA Los Angeles, CA Plymouth, IN Salem, OR Dallas, TX
	Engineering Support Team: 1-888-753-7446
PART NO.	BTS1216-C
DWG. NO.	BTS1216-C